

Mercedes-Benz

# THE ALL-NEW C-CLASS ELECTRIC

Model Year 807 (Launch)  
From July 2026 production





Model Overview



Colours



Upholsteries & Trim



Wheels



Optional Equipment

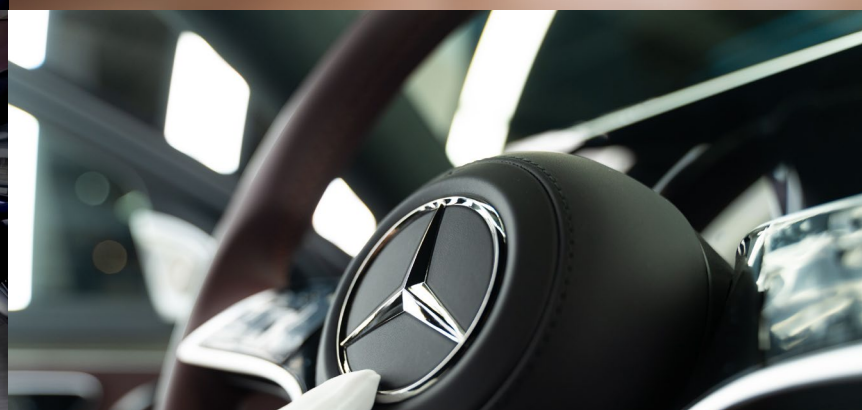

Pricing



Standard Equipment



Technical Data



Further Information



Digital Extras



Services & Insurance



Roadside Assistance



Home Charging - Ohme



Home Charging - PodPoint



MB.CHARGE Public



Online Showroom



Configurator



Genuine Accessories

Model Overview



Sport



AMG Line



AMG Line Premium



AMG Line Premium Plus



Premier Edition





Sport



Some of the model features, optional extras and colours shown may not be available, or may be available in a different specification, or at a different price. Option shown: ARTICO man-made leather in black



## Exterior Highlights

- 101 Litre 'Frunk' Front Storage Compartment [1]
- 19" Multi-Spoke Light-Alloy Wheels with Summer Tyres [2]
- AVANTGARDE Bodystyling with Beltlines and Window Lines in Polished Aluminium
- Heat and Noise Insulating Acoustic Glass
- LED High Performance Headlamps with Active Highbeam Assist [6]
- Mercedes-Benz Iconic Grille with Surround and Panel in Silver Chrome [4]
- Privacy Glass
- Ambient Lighting with Projection of Brand Logo
- Panoramic glass roof [3]

## Interior Highlights

- Anodised Look Anthracite Trim [5]
- Comfort Seats with ARTICO Man-Made Leather Upholstery, Black Seat Belts, Lumbar Support and Electric Adjustment Heated Front Seats [7]
- Multifunction Sports Steering Wheel in Nappa Leather [5]
- THERMATIC 2-Zone Climate Control
- Roof Liner in Black Fabric
- Interior Light Package
- USB Package Plus

## Technology Highlights

- 10.3" Driver Display, 14" Central Display and 14" Digital Trim Panel [5]
- Blind Spot Assist, Active Lane Keeping Assist, Brake Assist and Traffic Sign Assist
- Electric Charging Flap with DC charging up to 330kW, AC Charging up to 11kW [9]
- Parking Package with MB.DRIVE PARKING ASSIST and Reversing Camera [8]
- PRE-SAFE® System
- Smartphone Integration and Wireless Charging for Mobile devices
- Selfie and Video Camera



AMG Line



Some of the model features, optional extras and colours shown may not be available, or may be available in a different specification, or at a different price. Option shown: ARTICO man-made leather in black



### Exterior Highlights

- 19" AMG 5-spoke Light-Alloy Wheels with Summer Tyres [1]
- AMG Line Bodystyling with Beltlines and Window Lines in Polished Aluminium [9]
- Mercedes-Benz Iconic Grille with Panel in Dark Chrome with Partially Illuminated Mercedes-Benz Star [4]
- Surround Lighting via LDC Projector in the Front Doors with Animated Projection of the Mercedes-Benz Pattern
- Panoramic glass roof with SKY CONTROL [3]

### Interior Highlights

- Ambient Lighting Package incl. 64 Colours, 10 Colour Schemes, 3 Dimming Zones and 20 Levels of Brightness [8]
- AMG Floor Mats and Aluminium Sports Pedals
- AMG Line Sport Seat package with ARTICO Man-Made Leather Upholstery and Black Seat Belts [5]
- Grey Open-Pore Finition Birch Wood Trim [6]
- Illuminated Door Sills with Interchangeable Cover
- Instrument Panel and Beltlines in ARTICO Man-Made Leather in Nappa Look
- Memory Seat Package [7]
- Multifunction Sports Steering Wheel in Nappa Leather [2]

### Technology Highlights

- Digital AMG Line: Specific Features of the MBUX Multimedia System and Sound World
- Digital Extra: MBUX Entertainment for 3 Years
- MBUX Superscreen: 10.3" Driver Display, 14" Central Display and 14" Passenger Display [8]





AMG Line  
Premium





### Exterior Highlights

- 19" AMG 5-twin-Spoke Light-Alloy Wheels with Summer Tyres [1]
- DIGITAL LIGHT Headlamps with Intelligent Light Modes, Topographical Compensation, Active Highbeam Assist Plus and Dynamic ULTRA RANGE Highbeam [2]
- KEYLESS GO Convenience Package: HANDS-FREE ACCESS, Flush-Fitting Door Handles, EASY-PACK tailgate and KEYLESS-GO [3]

### Interior Highlights

- Active Ambient Lighting
- Ambient Lighting Plus [6]
- Dual Wireless Charging [4]
- Winter Package incl. Heated Steering Wheel and Heated Windscreen Wiper Blades

### Technology Highlights

- 39.1" MBUX HYPERSCREEN [6,7]
- Burmester® 3D Surround Sound System with 15 speakers, 670 Watts, Automatic Sound Focus, Sound Personalisation and Dolby Atmos® Technology [8]
- Digital Vehicle Key for Smartphone
- ENERGIZING Air Control: Air Quality Monitoring incl. Two-Stage Filter
- MBUX Augmented Reality Navigation [5]
- Parking Package with 360° Camera [9]

Some of the model features, optional extras and colours shown may not be available, or may be available in a difference specification, or at a different price



AMG Line  
Premium Plus



Some of the model features, optional extras and colours shown may not be available, or may be available in a different specification, or at a different price. Option shown: optional hand-made leather in ivory beige/black



### Exterior Highlights

- 20" AMG Multi-Spoke Light-Alloy Wheels with Summer Tyres [1,9]

### Interior Highlights

- Black Open-Pore Fineline Ship's Deck Wood Trim [2]
- Heated Rear Seats [3]
- High-End Sports Seats: Massage, Climate Control Function and Extensive Electrical Adjustment Options and PRE-SAFE® Impulse Side [5]
- Illuminated Pattern in the Panoramic Roof [6]

### Technology Highlights

- Burmester® High-End 4D Surround Sound System: 19 Speakers, 2 Exciters, 750 Watts, Dolby Atmos® Technology and Sound Personalisation [4]
- MBUX Augmented Navigation Head-up Display [7]
- Projection Functions for DIGITAL LIGHT Headlamps





Premier Edition



Some of the model features, optional extras and colours shown may not be available, or may be available in a different specification, or at a different price. Option shown black leather with red topstitch



## Exterior Highlights

- 20" AMG Multi-Spoke Light-Alloy Wheels with Summer Tyres [4]
- AMG Line Plus Bodystyling with Beltlines and Window Lines in High-Gloss black [3,5,6]
- AMG Spoiler Lip in High-Gloss Black [3]
- Night Package with Exterior Mirror Housing in High-Gloss Black [8]
- Mercedes-Benz Iconic Grille with Illuminated Surround and Illuminated Panel with Frame and Panel in Dark Chrome [1]

## Interior Highlights

- Black / Silver Metallic Mixed Fabric Trim [2]
- Illuminated Door Sills with Interchangeable Cover in Black
- Leather Upholstery in Black with Contrasting Topstitching in Red, with Black Seat Belts [9]
- Vehicle Key in High-Gloss Black



Personalisation



**Polar White solid**  
[149] - Standard



**Obsidian Black metallic**  
[197] - £750



**High-Tech Silver metallic**  
[922] - £750

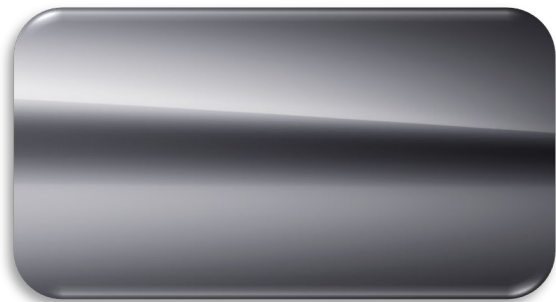

**Lavender Silver metallic**  
[689] - £750

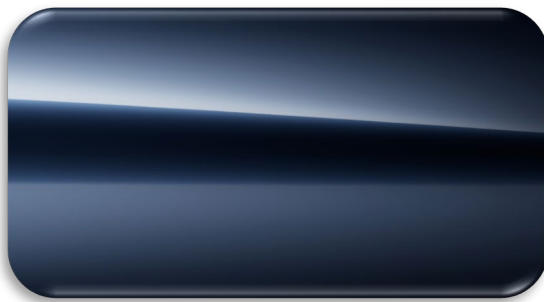

**Sodalite Blue metallic**  
[842] - £750



**Sapphire Blue metallic**  
[809] - £750



*Manufaktur*  
**Alpine Grey solid**  
[956] - £1,000



*Manufaktur*  
**Opalite White Bright metallic**  
[885] - £1,000



*Manufaktur*  
**Patagonia Red metallic**  
[993] - £1,000



## Personalisation

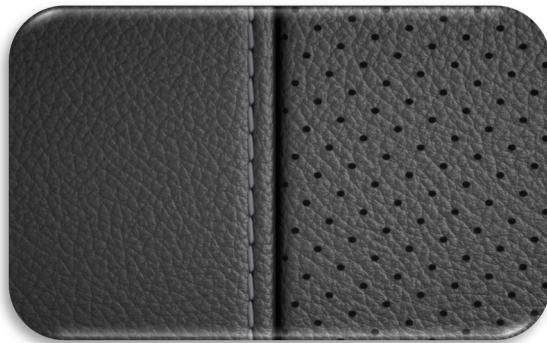

ARTICO man-made leather in black [101A]

Sport	✓
AMG Line	–
AMG Line Premium	–
AMG Line Premium Plus	–
Premier Edition	–

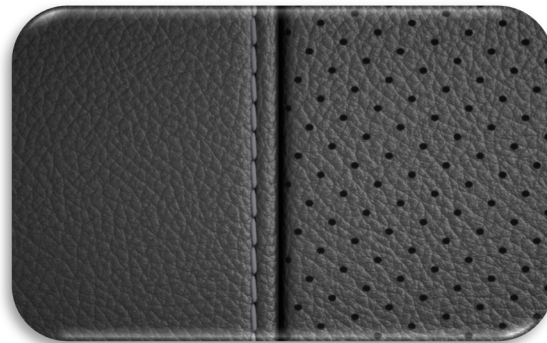

ARTICO man-made leather in black [111A]

Sport	–
AMG Line	✓
AMG Line Premium	✓
AMG Line Premium Plus	✓
Premier Edition	–



ARTICO man-made leather in beech brown/black [114A]

Sport	–
AMG Line	○
AMG Line Premium	○
AMG Line Premium Plus	○
Premier Edition	–



ARTICO man-made leather in ivory beige/black [115A]

Sport	–
AMG Line	○
AMG Line Premium	○
AMG Line Premium Plus	○
Premier Edition	–



Leather¹ in black with red topstitch [231A]

Sport	–
AMG Line	–
AMG Line Premium	–
AMG Line Premium Plus	–
Premier Edition	✓



Nappa leather² in tagua brown/black [804A]

Sport	–
AMG Line	–
AMG Line Premium	–
AMG Line Premium Plus	£2,000
Premier Edition	–

## Personalisation



Anthracite anodised-look trim [59H]

Sport	✓
AMG Line	–
AMG Line Premium	–
AMG Line Premium Plus	–
Premier Edition	–

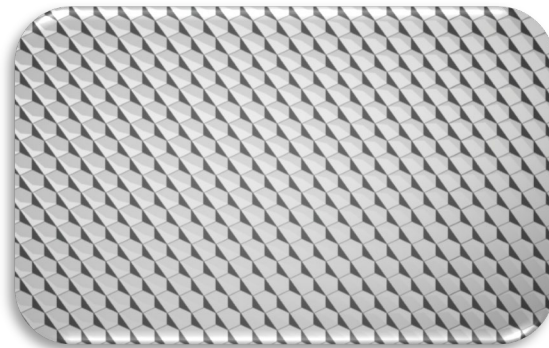

White open-pore natural fibre honeycomb design trim [27H]

Sport	○
AMG Line	–
AMG Line Premium	–
AMG Line Premium Plus	–
Premier Edition	–

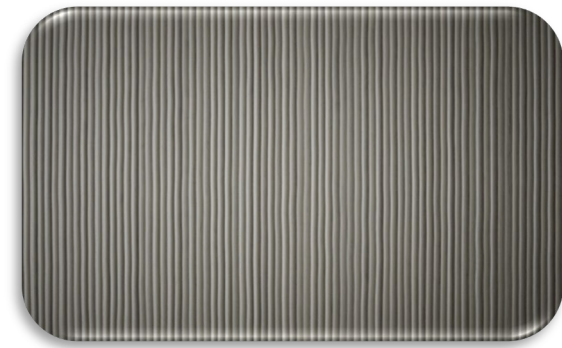

Grey open-pore fineline birch wood trim [25H]

Sport	–
AMG Line	✓
AMG Line Premium	✓
AMG Line Premium Plus	–
Premier Edition	–

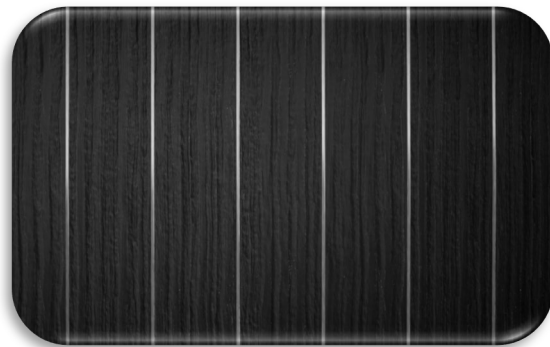

Black open-pore fineline ship's deck wood trim [24H]

Sport	–
AMG Line	–
AMG Line Premium	–
AMG Line Premium Plus	✓
Premier Edition	–

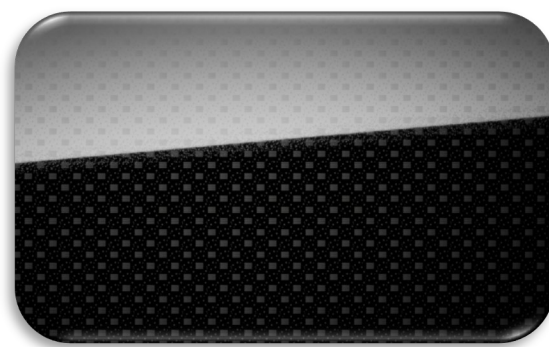

Black/silver metallic mixed fabric trim [H75]

Sport	–
AMG Line	–
AMG Line Premium	–
AMG Line Premium Plus	–
Premier Edition	✓

## Personalisation



19" multi-spoke light-alloy wheels [R09]

Sport	✓
AMG Line	–
AMG Line Premium	–
AMG Line Premium Plus	–
Premier Edition	–



19" AMG 5-spoke light-alloy wheels [RRE]

Sport	–
AMG Line	✓
AMG Line Premium	–
AMG Line Premium Plus	–
Premier Edition	–



19" AMG 5-twin-spoke light alloy wheels [RSU]

Sport	–
AMG Line	–
AMG Line Premium	✓
AMG Line Premium Plus	–
Premier Edition	–



20" AMG multi-spoke light-alloy wheels [RVM]

Sport	–
AMG Line	–
AMG Line Premium	–
AMG Line Premium Plus	✓
Premier Edition	–



20" AMG multi-spoke light-alloy wheels [RVO]

Sport	–
AMG Line	–
AMG Line Premium	–
AMG Line Premium Plus	–
Premier Edition	✓



## Sustainability Package [DSP]

### No-cost option

The Sustainability Package combines the Vegan Package including:

- Multifunction sports steering wheel in ARTICO man-made leather
- White open-pore natural fibre honeycomb design sustainable trim

The globally renowned 'The Vegan Society' has evaluated and certified as vegan all soft-touch surface materials in the Vegan Package for the interior of the electric GLC – from the seat upholstery to headliner, from pillar and door panels to carpeting. Customers can be assured that the tested surfaces made from the high-quality ARTICO man-made leather and textiles contain no animal-derived products.

The white open-pore natural fibre honeycomb design sustainable trim lends your vehicle interior an individual look. It blends in harmoniously while also creating exciting contrasts, thereby reinforcing and emphasising the interior design. At the same time, the trim element is an enduring quality attribute of a meticulously crafted premium product.

Sport	○
AMG Line	–
AMG Line Premium	–
AMG Line Premium Plus	–
Premier Edition	–

✓ indicates standard equipment, ○ indicates optional at no extra cost, – indicates not available, ● indicates a cost option. Price shown inclusive of VAT.



## Refinement Package [DRP]

£2,500

Elevating your driving experience to unprecedented levels with the Refinement Package.

With AIRMATIC air suspension and rear axle steering, you experience noticeably more driving comfort and agility. The air suspension impresses with either sporty dynamics or high comfort. Thanks to rear axle steering, you benefit from particularly agile or confident handling, depending on the speed, and a smaller turning circle.

The package consists of:

- AIRMATIC air suspension
- Rear axle steering (up to 4.5°)

The AIRMATIC system includes:

- Adjustable suspension level
- Intelligent damper adjustment
- Intelligent damper control
- Intelligent level control
- Lowering the rear for easier loading and unloading

Sport	–
AMG Line	•
AMG Line Premium	•
AMG Line Premium Plus	•
Premier Edition	•

✓ indicates standard equipment, ○ indicates optional at no extra cost, – indicates not available, • indicates a cost option. Price shown inclusive of VAT.





## Trailer Coupling with ESP® Trailer Stabilisation [550]

£1,000

Expand your transport options: You can hitch up trailers or caravans as well as mount bicycle racks. The fully electric trailer hitch moves into position at the press of a button or swings completely back after use – without you having to get your hands dirty.

The package includes:

- ESP® trailer stabilisation
- Tow bar

When towing a trailer, ESP® trailer stabilisation can automatically intervene in critical situations. It is automatically active from a speed of 40 mph.

If undesirable swaying movements are detected, the trailer stabilisation actively dampens them with the help of wheel-specific, reciprocal brake applications. In most cases this is already sufficient to reduce dangerous vibrations. If necessary, the system also reduces the speed: for this purpose, the engine torque is reduced and the vehicle is braked over all 4 wheels. Your vehicle recognises the trailer automatically as soon as the electric plug is connected.

Sport	•
AMG Line	•
AMG Line Premium	•
AMG Line Premium Plus	•
Premier Edition	•

✓ indicates standard equipment, ○ indicates optional at no extra cost, – indicates not available, • indicates a cost option. Price shown inclusive of VAT.



## 22kW AC Charging [84B]

£1,000

With the enhanced AC charging system, you can charge your vehicle quickly and easily with up to 22 kW (3-phase) at suitable public charging stations or wallboxes.

This shortens your charging times considerably if you have high-powered AC charging available to you.

Sport

•

AMG Line

•

AMG Line Premium

•

AMG Line Premium Plus

•

Premier Edition

•

✓ indicates standard equipment, ○ indicates optional at no extra cost, - indicates not available, ● indicates a cost option. Price shown inclusive of VAT.

## Pricing

	Powertrain	Electric Range	CO <sub>2</sub>	Basic RRP excl. VAT	Total RRP incl. VAT	Road Fund Licence	Rec. OTR Price	P11D Value	BIK Tax Rate 2026/27
Sport	C-Class 400 4MATIC electric	452	0	£47,604.17	£57,125	£10.00	£57,995	£57,930	4%
AMG Line	C-Class 400 4MATIC electric	447	0	£50,104.17	£60,125	£10.00	£60,995	£60,930	4%
AMG Line Premium	C-Class 400 4MATIC electric	442	0	£54,270.83	£65,125	£10.00	£65,995	£65,930	4%
AMG Line Premium Plus	C-Class 400 4MATIC electric	433	0	£56,354.17	£67,625	£10.00	£68,495	£68,430	4%
Premier Edition	C-Class 400 4MATIC electric	428	0	£58,437.50	£70,125	£10.00	£70,995	£70,930	4%

<sup>1</sup>The indicated values were determined according to the prescribed measurement method - Worldwide Harmonised Light Vehicle Test Procedure (WLTP). Figures shown may include options which are not available in the UK. Battery Electric Vehicles (BEV) require mains electricity for charging, range figures determined with the battery fully charged. These models require mains electricity for charging. <sup>2</sup>Figures shown are for comparability purposes; only compare with other cars tested to the same technical procedures. Figures may not reflect real life driving results, which will depend upon a number of factors including factory-fitted options, accessories fitted (post registration), variations in weather, driving styles and vehicle load. Further information about the test used to establish fuel consumption and CO<sub>2</sub> figures can be found at <http://www.mercedes-benz.co.uk/WLTP> <sup>3</sup>A different first year rate of Vehicle Excise Duty (Road Fund Licence) applies for new cars. <sup>4</sup>The recommended on-the-road price includes the Road Fund Licence applicable to the standard model plus delivery charge (£780.00 incl. VAT), new vehicle registration fee (£55.00) and number plates (£25.00 incl. VAT). VAT is calculated at the standard rate of 20%. Some of the model features, optional extras and colours shown may not be available, or may only be available in a different specification, or at a different price

# Standard Equipment

	Sport	AMG Line	AMG Line Premium	AMG Line Premium Plus	Premier Edition
<b>Battery &amp; Charging</b>					
Charging Cable - Mode 3 for wallbox and public charging stations, 5m straight	✓	✓	✓	✓	✓
AC Charging System (11kW)	✓	✓	✓	✓	✓
DC Charging System (330kW)	✓	✓	✓	✓	✓
DC Charging System (compatible with 400V)	✓	✓	✓	✓	✓
Electric vehicle charging flap	✓	✓	✓	✓	✓
<b>Engine, Transmission &amp; Suspension</b>					
4MATIC four-wheel drive - variable all-wheel drive system designed for all weather traction	✓	✓	✓	✓	✓
Comfort suspension - with passive selective damping system	✓	✓	✓	✓	✓
DYNAMIC SELECT with a choice driving modes (Eco, Comfort, Sport, Individual and Terrain)	✓	✓	✓	✓	✓
<b>Exterior</b>					
AVANTGARDE bodystyling	✓	-	-	-	-
AMG Line bodystyling	-	✓	✓	✓	✓
AMG Line Plus bodystyling	-	-	-	-	✓
Night Package - additional gloss-black design elements	-	-	-	-	✓
AMG Spoiler Lip - high-gloss black	-	-	-	-	✓
Roof rails in silver chrome	✓	✓	✓	✓	-
Surround lighting in the outside mirrors with Mercedes-Benz logo	✓	✓	✓	✓	✓
Surround lighting via LCD projectors in the front doors with animated projection of the Mercedes-Benz pattern	-	✓	✓	✓	✓
Mercedes-Benz iconic grille with light-coloured panel in silver chrome	✓	-	-	-	-
Mercedes-Benz iconic grille with illuminated surround and illuminated panel in dark chrome	-	✓	✓	✓	✓
Mercedes-Benz iconic grille with illuminated surround and illuminated panel with frame and panel in dark chrome	-	-	-	-	✓
Bow design door handles	✓	✓	-	-	-
Seamless door handles with keyless entry	-	-	✓	✓	✓
LED High Performance headlamps including integral LED daytime running lamps and Adaptive Highbeam Assist	✓	✓	✓	-	-
DIGITAL LIGHT- HD light system with intelligent light modes, topographical compensation, Adaptive Highbeam Assist Plus and dynamic ULTRA RANGE Highbeam.	-	-	✓	-	-
DIGITAL LIGHT - with additional projection functions	-	-	-	✓	✓
LED Tail Lamps	✓	✓	✓	✓	✓
Brake callipers with 'Mercedes-Benz' lettering	✓	✓	✓	✓	✓
EASY-PACK automatic powered tailgate - can be opened and closed at the touch of a button for more convenient loading and unloading of the boot	-	-	✓	✓	✓
Heat and Noise Insulating Acoustic Glass for front windows	✓	✓	✓	✓	✓
Heat Insulating Dark Tinted Privacy Glass	✓	✓	✓	✓	✓
SKY CONTROL panoramic glass roof - Control the transparency of the panoramic roof as desired – crystal clear or matt	-	-	✓	✓	✓
Illuminated Mercedes-Benz pattern in the glass of the panoramic roof	-	-	-	✓	✓
Mirror Package - Electrically folding mirrors and automatically dimming rear view mirror	✓	✓	✓	✓	✓
Heated windscreen wiper blade	-	-	✓	✓	✓
<b>Wheels</b>					
19" multi-spoke light-alloy wheels - with 235/50 R19 tyres on 8.0 J x 19 ET 38.1 wheels at the front axle and 255/45 R19 tyres on 9.0 J x 19 ET 58.6 wheels at the rear axle	✓	-	-	-	-
19" AMG 5-spoke light-alloy wheel - with 235/50 R19 tyres on 8.0 J x 19 ET 38.1 wheels at the front axle and 255/45 R19 tyres on 9.0 J x 19 ET 58.6 wheels at the rear axle	-	✓	-	-	-
19" AMG 5-twin-spoke light-alloy wheels - with 235/50 R19 tyres on 8.0 J x 19 ET 38.1 wheels at the front axle and 255/45 R19 tyres on 9.0 J x 19 ET 58.6 wheels at the rear axle	-	-	✓	-	-
20" AMG multi-spoke light-alloy wheels - with 235/45 R20 tyres on 8.0 J x 20 ET 30.6 wheels at the front axle and 255/40 R20 tyres on 9.0 J x 20 ET 58.6 wheels at the rear axle	-	-	-	✓	-
20" AMG multi-spoke light-alloy wheels - with 235/45 R20 tyres on 8.0 J x 20 ET 30.6 at the front axle and 255/40 R20 tyres on 9.0 J x 20 ET 58.6 at the rear axle	-	-	-	-	✓
<b>Interior</b>					
Floor mats - velour	✓	-	-	-	-
Floor mats - Black with AMG lettering	-	✓	✓	✓	✓
AMG brushed stainless steel sports pedals with black rubber studs	-	✓	✓	✓	✓
Interior light Package - the Interior Light Package provides comprehensive direct and indirect lighting. The LED lighting elements create a pleasant atmosphere and make it easier for you to operate in the dark.	✓	-	-	-	-
Ambient Lighting - at the front and in the rear, including a lighting line from the windscreen to the rear doors, 64 colours and 10 colour worlds	-	✓	✓	-	-
Ambient Lighting Plus - based on the ambient lighting, with an additional light line on the contour of the centre console trim element, 64 colours and 10 colour worlds	-	-	✓	✓	✓
Active Ambient Lighting - Enjoy visual displays, for example when you change the temperature setting, listen to music or communicate with the MBUX voice assistant. The warnings of some driver assistance and parking systems are also supported by the active ambient lighting. The lighting effects can be multi-coloured and animated.	-	-	✓	✓	✓
Door sill panels with 'Mercedes-Benz' lettering	✓	-	-	-	-



✓ indicates standard equipment, ○ indicates optional at no extra cost, - indicates not available, ● indicates a cost option.

# Standard Equipment

	Sport	AMG Line	AMG Line Premium	AMG Line Premium Plus	Premier Edition
Illuminated door sill panels with Mercedes-Benz lettering	•	•	•	•	•
Illuminated door sill panels in black with Mercedes-Benz lettering	•	•	•	•	•
KEYLESS-GO starting function - push-button start	•	•	•	•	•
KEYLESS-GO Comfort Package - start and lock/unlock the car without touching the key. The tailgate can also be opened and closed with a kicking motion beneath the rear bumper	•	•	•	•	•
Boot Comfort Package - Practical load compartment equipment, including electrically folding rear seat backrests, height-adjustable load floor and 12 V socket	•	•	•	•	•
Split-Folding Rear Seats 40:20:40	•	•	•	•	•
Load Compartment Cover - Removable roller blind to protect your luggage	•	•	•	•	•
Partly Electric Frunk - Conveniently unlock the frunk by touching the Mercedes-Benz badge on the bonnet	•	•	•	•	•
Electro-pneumatic 4-way lumbar support	•	•	•	•	•
Memory Package - Memory option for the seat position, lumbar support, steering column and outside mirrors settings for up to 3 people	•	•	•	•	•
Heated Front Seats	•	•	•	•	•
Climatised Front Seats - Heated and Cooled	•	•	•	•	•
Multicontour Massaging Front Seats	•	•	•	•	•
Heated rear seats	•	•	•	•	•
Double cupholder in centre console	•	•	•	•	•
Front centre armrest with stowage compartment	•	•	•	•	•
Illuminated and lockable glove compartment	•	•	•	•	•
THERMATIC two-zone automatic climate control	•	•	•	•	•
<b>Steering</b>					
3-spoke steering wheel in fine nappa leather with user-friendly control panels for the most distraction-free input possible	•	•	•	•	•
Multifunction sports steering wheel in nappa leather is flattened at the bottom and deeply embossed in the grip area - perfect for sporty driving	•	•	•	•	•
Heated Steering Wheel	•	•	•	•	•
<b>Paint, Trim and Upholstery</b>					
Comfort Seats - Seats designed for maximum seating comfort with extensive electrical adjustment options and 4-way adjustable head restraints	•	•	•	•	•
Sports Seats - Sports seats in integral look with specific seat graphics and adjustable head restraints as well as extensive electrical adjustment options	•	•	•	•	•
High-end Sports Seats -Sports seats in integral look with specific seat graphics, massage and climate control function and extensive electrical adjustment options	•	•	•	•	•
Upholstery in ARTICO man-made leather	•	•	•	•	•
Upholstery in leather	•	•	•	•	•
Trim elements anodised look anthracite	•	•	•	•	•
Trim elements in grey open-pore fineline birch wood	•	•	•	•	•
Trim elements in black open-pore fineline ship's deck wood	•	•	•	•	•
Black/silver metallic mixed fabric trim	•	•	•	•	•
Instrument panel and beltlines in ARTICO man-made leather in nappa look	•	•	•	•	•
Black fabric roof liner	•	•	•	•	•
Black seat belts	•	•	•	•	•
Paint - Solid	•	•	•	•	•
<b>Safety and Assistance Systems</b>					
Acoustic presence indicator	•	•	•	•	•
Active bonnet - pedestrian safety measures which detects a collision and raises the bonnet to soften the impact	•	•	•	•	•
Variable speed limiter	•	•	•	•	•
Adaptive cruise control	•	•	•	•	•
Blind spot monitoring	•	•	•	•	•
Lane support system	•	•	•	•	•
Traffic sign assist	•	•	•	•	•
Extended Traffic sign assist	•	•	•	•	•
Autonomous emergency braking	•	•	•	•	•
Escalating emergency stop function	•	•	•	•	•
Emergency steering support	•	•	•	•	•
Door opening warning	•	•	•	•	•
Collision prevention manoeuvring	•	•	•	•	•
Active blind spot monitoring	•	•	•	•	•
Rear view camera	•	•	•	•	•



✓ indicates standard equipment, ○ indicates optional at no extra cost, - indicates not available, ● indicates a cost option.

# Standard Equipment

	Sport	AMG Line	AMG Line Premium	AMG Line Premium Plus	Premier Edition
PRE-SAFE® system - Preventive occupant protection, including PRE-SAFE® Curve, PRE-SAFE® Sound, reversible belt tensioning and closing function for the side windows	✓	✓	✓	✓	✓
Increased anti-theft protection	✓	✓	✓	✓	✓
Parking Package with MB.DRIVE PARKING ASSIST and reversing camera	✓	✓	✓	✓	✓
Parking package with 360° camera	-	-	-	-	✓
TIREFIT with Tyre Inflation Compressor	✓	✓	✓	✓	✓
Tyre Pressure Monitoring System	✓	✓	✓	✓	✓
<b>Communication and In-Car Entertainment</b>					
10.3" Driver display, 14" central display and 14" digital trim panel	✓	-	-	-	-
MBUX Superscreen - 10.3" Driver display, 14" central display and 14" passenger display	-	-	-	-	-
39.1" (99.1 cm) MBUX HYPERSCREEN with 8K resolution, 7,680 x 1,260 pixels, 220 PPI 60Hz refresh rate and matrix backlighting	-	-	-	-	✓
DAB digital radio tuner	✓	✓	✓	✓	✓
Smartphone integration including Android Auto™ and Apple CarPlay™	✓	✓	✓	✓	✓
Selfie & video camera	✓	✓	✓	✓	✓
USB package plus - 4 fast-charging USB-C ports for your mobile devices – 2 at the front and 2 in the rear	✓	✓	✓	✓	✓
Burmester 3D - Impressive 3D sound with 15 speakers, 670 watts of system output and automatic sound focus thanks, among other things, to seat recognition and Dolby Atmos®	-	-	-	-	-
Burmester high-end 4D surround sound system - Unique 4D sound with 19 speakers, 4 exciters in the seats, 750 watts of system output as well as automatic sound focus and Dolby Atmos	-	-	-	-	✓
Hard-Disk Navigation	✓	-	✓	✓	✓
Head-up Display	-	-	-	-	✓
MBUX Augmented Reality Navigation	-	-	-	-	✓
Wireless charging system for mobile devices in the front	✓	✓	-	-	-
Wireless charging system for mobile devices in the front -dual	-	-	✓	✓	✓
<b>Digital Services</b>					
Digital Extra: MBUX Entertainment - 3 years	✓	✓	✓	✓	✓
Digital extra: MBUX Navigation - 7 years	✓	✓	✓	✓	✓
Digital Extra: Remote Services - unlimited	✓	✓	✓	✓	✓
Digital Extra: MB.CHARGE Public - unlimited	✓	✓	✓	✓	✓
Digital Extra: Keyless Go in smartphone - unlimited	-	-	-	-	✓
MB e-Call system - 10 years	✓	✓	✓	✓	✓
GUARD 360° Vehicle Protection Plus - 3 years	✓	✓	✓	✓	✓



✓ indicates standard equipment, ○ indicates optional at no extra cost, - indicates not available, ● indicates a cost option.

# Optional Equipment

			Sport	AMG Line	AMG Line Premium	AMG Line Premium	Premier Edition
<b>Sustainability Package</b>		DSP	-	○	-	-	-
Vegan Package including ARTICO steering wheel			^	-	-	-	-
Trim element in white open-pore natural fibre honeycomb design			^	-	-	-	-
<b>Trailer Coupling with ESP Stabilisation</b>		550	£1,000	•	•	•	•
Tow Bar			^	^	^	^	^
ESP Trailer Stabilisation			^	^	^	^	^
<b>Refinement Package</b>		DRP	£2,500	-	•	•	•
AIRMATIC Air Suspension			-	^	^	^	^
Rear Axle Steering (up to 4.5°)			-	^	^	^	^
<b>Solid Paint</b>							
Polar White	[149U]	Standard	✓	✓	✓	✓	✓
<b>Metallic Paint</b>							
Obsidian Black	[197U]	£750	•	•	•	•	•
High-tech Silver	[922U]	£750	•	•	•	•	•
Lavender Silver	[689U]	£750	•	•	•	•	•
Sodalite Blue	[842U]	£750	•	•	•	•	•
Sapphire Blue	[809U]	£750	•	•	•	•	•
<b>MANUFAKTUR Paint</b>							
Alpine Grey Solid	[956U]	£1,000	•	•	•	•	•
Opalite White Bright	[885U]	£1,000	•	•	•	•	•
Patagonia Red Metallic	[993U]	£1,000	•	•	•	•	•
<b>Upholstery</b>							
AMG Line sports seats - ARTICO man-made leather in beech brown / black	[114A]	£0	-	0	0	0	-
AMG Line sports seats - ARTICO man-made leather in ivory beige / black	[115A]	£0	-	0	0	0	-
AMG Line sports seats - nappa leather in tagua brown/black	[804A]	£2,000	-	-	-	•	-
<b>22kW AC Charging</b>		84B	£1,000	•	•	•	•



✓ indicates standard equipment, ○ indicates optional at no extra cost, - indicates not available, • indicates a cost option, ^ indicates part of a package

# Technical Data

CO2 & Consumption Values						
Engine	Fuel Type	Transmission	Model Variant	CO2 Combined (g/km)	Energy Consumption – combined (Wh/km) <sup>1</sup>	EAER Electric Range MILES
C-Class 400 4MATIC electric	EV	2 Speed Transmission	Sport	0	150	452
			AMG Line	0	152	447
			AMG Line Premium	0	154	442
			AMG Line Premium Plus	0	158	433
			Premier Edition	0	160	428

Wheels & Tyres				
Model	Wheel Code	Description	Front	Rear
Sport	R09	19" multi-spoke light-alloy wheels	235/50/R19	255/45/R19
AMG Line	RRE	29" AMG 5-spoke light-alloy wheels	235/50/R19	255/45/R19
AMG Line Premium	RSU	19" AMG 5-twin-spoke light-alloy wheels	235/50/R19	255/45/R19
AMG Line Premium Plus	RVM	20" AMG multi-spoke light-alloy wheels	235/45/R20	255/40/R20
Premier Edition	RVO	20" AMG multi-spoke light-alloy wheels	235/45/R20	255/40/R20

<sup>1</sup>Figures shown are for comparability purposes; only compare with other cars tested to the same technical procedures. Figures may not reflect real life driving results, which will depend upon a number of factors including the starting charge of the battery, factory-fitted options, accessories fitted (post registration), variations in weather, driving styles and vehicle load. Further information about the test used to establish range, power consumption and CO<sub>2</sub> figures can be found at [www.mercedes-benz.co.uk/WLTP](http://www.mercedes-benz.co.uk/WLTP).

# Technical Data

C-Class 400 4MATIC electric		
<b>Emissions</b>		
CO2 (g/km)		-
Emissions standard		Euro 6-WLTP
<b>Powertrain</b>		
Powertrain		Dual electric motor
Gearbox		2 speed transmission
Drive type		4x4 (AWD)
Electric motor type		PSM
Power	hp (kW)	489 (360)
Torque	Nm	800
<b>Powertrain</b>		
Acceleration (0-62mph)	sec	4.0
Top speed	mph	130
<b>Battery</b>		
Battery type		Lithium-ion
Battery capacity (useable)	kWh	94
Battery warranty		8 years / 100,000 miles
Battery capacity % guaranteed under warranty		70%
<b>Charging</b>		
On-board charger (AC)	kW	11 (22 optional)
Charging time - Wallbox 11kW AC	0-100%	10.50 hours
Charging time - Home Wallbox 7kW AC	0-100%	15.25 hours
On-board charger (DC)	kW	330
Charging time - public rapid charger (330kW)	10-80%	22 mins
<b>Range</b>		
Electric Range	miles	423 - 452
Electric energy consumption, combined	Wh/km	150 - 163
<b>Weights &amp; Capacities</b>		
Kerb weight	kg	2460
Permissible gross vehicle weight	kg	2,965
Boot capacity - seats up	litres	470
Frunk <sup>1</sup> capacity	litres	101
Frunk <sup>1</sup> capacity (ISO 3832)	litres	80
Maximum roof load	kg	75
Permissible trailer load (unbraked/braked [at 12%])	kg	750 / 1,800
Permissible tow ball weight	kg	80

<sup>1</sup>Figures according to Regulation (EC) No. 595/2009 in the currently applicable version. <sup>2,3</sup>Specified voltage and current values refer to network infrastructure and can be limited by the vehicle. Times are from 10-100% charge using a wallbox (three-phase) or standard socket (single-phase). <sup>4</sup>Specified voltage and current values refer to network infrastructure and can be limited by the vehicle. Times are from 10-80% charge using rapid public charging at 170kW. <sup>5</sup>Figures shown are for compatibility purposes; only compare with other cars tested to the same technical procedures. Figures may not reflect real life driving results, which will depend upon a number of factors including the starting charge of the battery, factory-fitted options, accessories fitted (post registration), variations in weather, driving styles and vehicle load. Further information about the test used to establish range, power consumption and CO2 figures can be found at [www.mercedes-benz.co.uk/WLTP](http://www.mercedes-benz.co.uk/WLTP). Specified voltage and current values refer to network infrastructure and can be limited by the vehicle

# Technical Data

## Sport

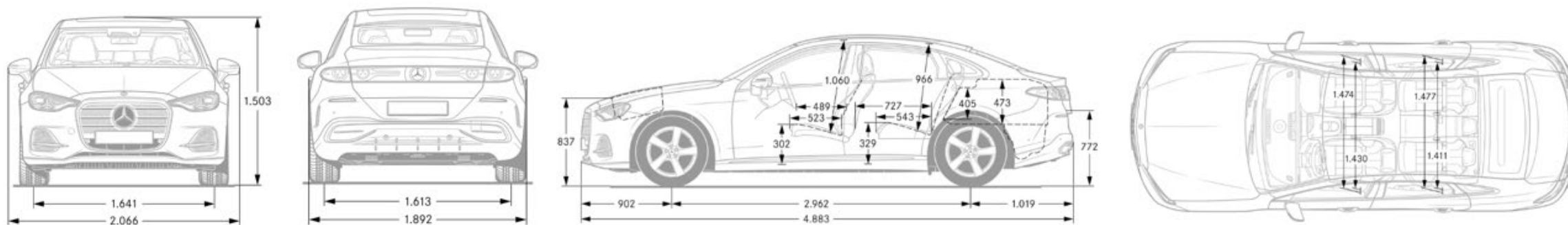

## AMG Line/AMG Line Premium/AMG Line Premium Plus/Premier Edition

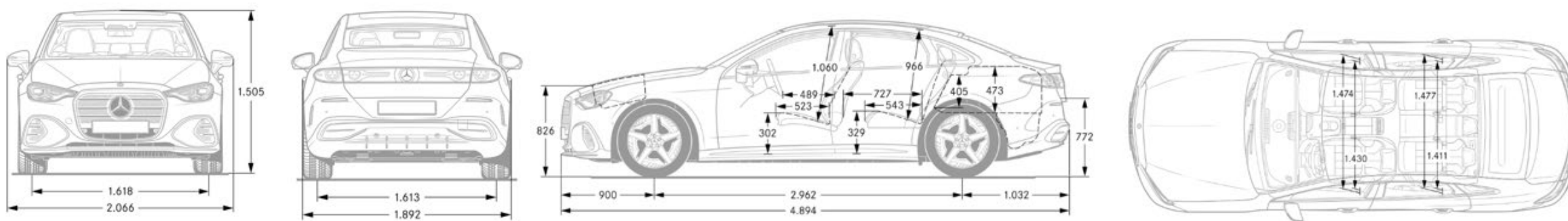

# Technical Data

C-Class electric		
Model Variant	Energy Consumption Combined (Wh/km) <sup>1</sup>	EAER Electric Range (Miles) <sup>1</sup>
<b>C-Class 400 4MATIC Sport</b>	<b>150</b>	<b>452</b>
C-Class 400 4MATIC Sport with Sustainability Package	150	452
C-Class 400 4MATIC Sport with Trailer Coupling	153	446
C-Class 400 4MATIC Sport with 22kW Charging	151	450
C-Class 400 4MATIC Sport with Sustainability Package & Trailer Coupling	153	446
C-Class 400 4MATIC Sport with Sustainability Package & 22kW Charging	151	450
C-Class 400 4MATIC Sport with Trailer Coupling & 22kW Charging	153	445
C-Class 400 4MATIC Sport with Sustainability Package, Trailer Coupling & 22kW Charging	153	445
<b>C-Class 400 4MATIC AMG Line</b>	<b>152</b>	<b>447</b>
C-Class 400 4MATIC AMG Line with Trailer Coupling	155	441
C-Class 400 4MATIC AMG Line with Refinement Package	152	447
C-Class 400 4MATIC AMG Line with 22kW Charging	153	446
C-Class 400 4MATIC AMG Line with Trailer Coupling & Refinement Package	154	442
C-Class 400 4MATIC AMG Line with Trailer Coupling & 22kW Charging	155	440
C-Class 400 4MATIC AMG Line with Refinement Package & 22kW Charging	152	446
C-Class 400 4MATIC AMG Line with Trailer Coupling, Refinement Package & 22kW Charging	155	441
<b>C-Class 400 4MATIC AMG Line Premium</b>	<b>154</b>	<b>442</b>
C-Class 400 4MATIC AMG Line Premium with Trailer Coupling	157	436
C-Class 400 4MATIC AMG Line Premium with Refinement Package	154	442
C-Class 400 4MATIC AMG Line Premium with 22kW Charging	155	441
C-Class 400 4MATIC AMG Line Premium with Trailer Coupling & Refinement Package	156	437
C-Class 400 4MATIC AMG Line Premium with Trailer Coupling & 22kW Charging	157	435
C-Class 400 4MATIC AMG Line Premium with Refinement Package & 22kW Charging	154	441
C-Class 400 4MATIC AMG Line Premium with Trailer Coupling, Refinement Package & 22kW Charging	157	436
<b>C-Class 400 4MATIC AMG Line Premium Plus</b>	<b>158</b>	<b>433</b>
C-Class 400 4MATIC AMG Line Premium Plus with Trailer Coupling	160	428
C-Class 400 4MATIC AMG Line Premium Plus with Refinement Package	157	434
C-Class 400 4MATIC AMG Line Premium Plus with 22kW Charging	158	432
C-Class 400 4MATIC AMG Line Premium Plus with Trailer Coupling & Refinement Package	160	429
C-Class 400 4MATIC AMG Line Premium Plus with Trailer Coupling & 22kW Charging	161	426
C-Class 400 4MATIC AMG Line Premium Plus with Refinement Package & 22kW Charging	158	433
C-Class 400 4MATIC AMG Line Premium Plus with Trailer Coupling, Refinement Package & 22kW Charging	160	428
<b>C-Class 400 4MATIC Premier Edition</b>	<b>160</b>	<b>428</b>
C-Class 400 4MATIC Premier Edition with Trailer Coupling	162	423
C-Class 400 4MATIC Premier Edition with Refinement Package	160	429
C-Class 400 4MATIC Premier Edition with 22kW Charging	160	427
C-Class 400 4MATIC Premier Edition with Trailer Coupling & Refinement Package	162	424
C-Class 400 4MATIC Premier Edition with Trailer Coupling & 22kW Charging	163	421
C-Class 400 4MATIC Premier Edition with Refinement Package & 22kW Charging	160	428
C-Class 400 4MATIC Premier Edition with Trailer Coupling, Refinement Package & 22kW Charging	162	423

<sup>1</sup>Figures shown are for compatibility purposes; only compare with other cars tested to the same technical procedures. Figures may not reflect real life driving results, which will depend upon a number of factors including the starting charge of the battery, factory-fitted options, accessories (post registration), variations in weather, driving styles and vehicle load. Further information about the test used to establish range, power consumption and CO2 figures can be found at [www.mercedes-benz.co.uk/WLTP](http://www.mercedes-benz.co.uk/WLTP)



Effective from July 2026 production. Information correct at time of publication 12.05.2026. Prices and specifications are subject to change without prior notice.