

TOYOTA COROLLA HATCH

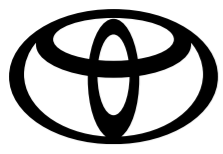

HAS IT ALL





SPECIFICATIONS

Corolla HB 1.8 HEV XR

Engine and Drivetrain

Bore x Stroke (mm)	80.5x88.3
Fuel System	Petrol Hybrid SFI
Maximum Power (kW @ r/min)	72 @ 5200
Maximum Torque (Nm @ r/min)	142 @ 3600
Number of Cylinders and Arrangement	Inline-4
Total System Output (kW)	103
Engine capacity (litre)	1.8
Fuel Consumption (Combined Cycle) (l/100km)	4.0
CO2 Emission (g/km)	91

Transmission

Transmission	CVT
Driven Wheels	FWD
Starting System	Push Start

Suspension

Front	MacPherson
Rear	Double-Wishbone

Wheels and Tyres

Spare Wheel	Space Saver 125-70D17
Tyre Size	F:225-40R18 Alloy- R:225-40R18 Alloy

Body and Styling

Antenna	Standard Shark Fin
Body Colour	Monotone
Daytime Running Light	•
Door Outside Handles	Colour - Coded
Front Bumper	Colour Coded
Front Fog Lamps	•
Headlights	Bi-LED - Auto High Beam, WNG
Headlamp Levelling	Standard Manual
Light Control System	Auto Light Control System, Guided Exit Lighting
Side mirrors	Black, Power, Auto-Retractable, With Indicator, Blind Spot Monitor (BSM), Heated
Rear Bumper	Black+Colour Coded
Rear Lights	LED
Rear Fog Lamp	•
Front Window Wiper	Auto, Rainsensing
Rear Spoiler	•

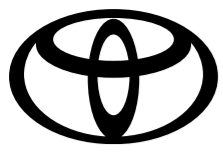

SPECIFICATIONS

Corolla HB 1.8 HEV XR

Interior, Comfort and Convenience

Cupholders	Standard 2
Floor Carpet Trim	Carpet With Heel Pad
Rear View Mirror	Electrochromatic (EC)
Meter Illumination Control	.
2nd Row Seats	60:40
Seat Trim	Leather + Suede
Shift Lever & Knob	Leather
Steering Wheel	3 Spoke Leather
Seat Back Pockets	Standard Driver and Passenger
Front Personal Lamp	Standard LED
Cruise Control	Standard Adaptive, All Speed
Airconditioner	Auto Dual zone
Audio System	Toyota Display Audio, 8-inch
Reverse Camera	Display Audio
Bluetooth	.
Front Seat Adjustment	Driver & Passenger Manual
Front Seat Vertical Adjuster	Driver Manual
Light Remind Warning	Standard Buzzer & Autocut-off
Multi-Information Display	Standard 12.3-inch
Navigation System	.
Power Socket	Front - 12V
Power Steering	Electric / (EPS)
Electric Windows	All All One Touch
Rear Armrest	Standard 2 Cupholders
Seat Heater	Standard Driver and Passenger only
Seat Lumbar Support	Power, Driver
Speakers	Standard 6
Steering Switches	Standard Audio, Telephone, Info Display, Voice Command, Adaptive Cruise Control, Lane Trace Assist
Sun Visor	Standard Lamp, Mirror with Cover
Wireless Charger	.
Android Auto & Apple CarPlay	.

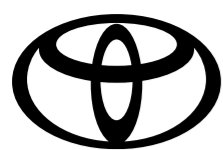

SPECIFICATIONS

Corolla HB 1.8 HEV XR

Interior, Comfort and Convenience

Toyota Connect Enabled	•
USB Type	Type C 4PCs

Safety and Security

Anti-Theft System	Siren Alarm + Immobiliser
Child Lock	Standard Rear door
Child Restraint System (ISOFIX)	Standard 2
Parking Brake	Electric
Front Brake	Ventilated Disc
Front Seat Belts	ELR, Pretensioner, Force Limiter
Power Door Lock	Standard
Pre-Crash System (Brake Synchronised)	•
Rear Brake	Disc
Rear Seat Belts	Standard ELR
Seat Belt Warning	Front + Rear Buzzer + Light
Wireless Door Lock	Standard Smart Entry
Airbags	Side, Curtain, Driver, Passenger, Driver Knee
Toyota Safety Sense	•

Driver Support Systems

Park Distance Control	Standard Front + Rear, Intelligent Clearance Sonar, Rear Cross Traffic Alert
Anti-Lock Braking System (ABS)	•
Blind Spot Monitor (BSM)	Standard Safe Exit Assist
Brake Assist (BA)	•
Electronic Brake Force Distribution (EBD)	•
Hill Assist Control (HAC)	•
Vehicle Stability Control (VSC)	•
Lane Keeping System	Standard Lane Trace Assist

Service and Warranty

Service Plan	6 Services / 90,000km
Service Interval	12 months / 15,000km
Warranty	3 years / 100,000km
Hybrid Battery Warranty	8 years 160,000km

Dimensions and Capacities

Front Overhang (mm)	940
Front Tread (mm)	1530
Fuel Tank Size (L)	43

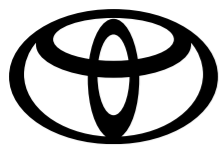

SPECIFICATIONS

Corolla HB 1.8 HEV XR

Dimensions and Capacities

Gross Combination Mass (GCM)	0
Ground Clearance (mm)	150
Gross Vehicle Mass (GVM)	1820
Height (mm)	1480
Length (mm)	4375
Luggage Capacity (L)	352
Rear Overhang (mm)	795
Rear Tread (mm)	1530
Towing Capacity - Unbraked (kg)	0
Towing Capacity - Braked (kg)	0
Wheelbase (mm)	2640
Width (mm)	1790
Top Speed (km/h)	180

LINE DRAWING

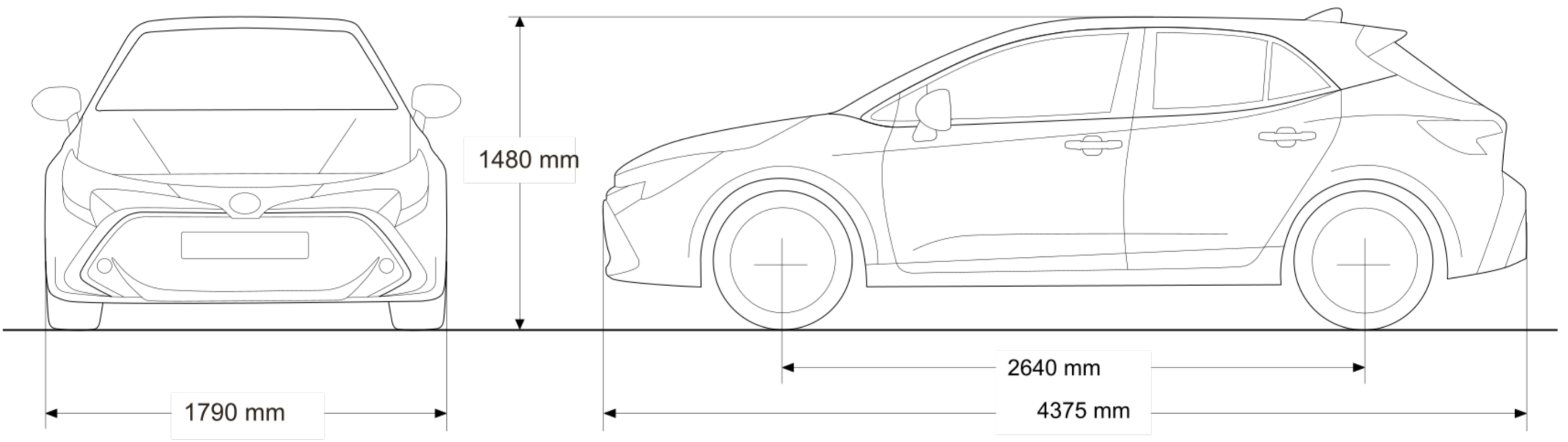

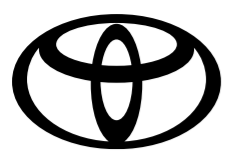

SPECIFICATIONS

EXTERIOR COLOURS

FOR ILLUSTRATIVE PURPOSES ONLY.

MONOTONE



040 - Glacier White



1F7 - Satin Silver
Metallic



1G3 - Graphite Grey
Metallic

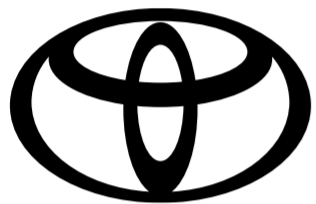

Disclaimer:

The information contained within or made available on any Toyota platform or note including but not limited to, this website/brochure/specification sheet, is provided for information purposes only. While we make reasonable efforts to update the information on our platform/s, Toyota Motor Corporation of Japan, and Toyota South Africa Motors (Pty) Ltd makes no representations, warranties, or guarantees, whether express or implied, that the content is accurate, complete or up to date, and all information contained herein is subject to change without notice.

Vehicle specifications may vary depending on the model, trim level, and market. Colours depicted on print and web material may not match the actual vehicle colour. Fuel consumption figures are estimates based on standardised testing conditions and actual results may vary due to (but not limited to) driving style, vehicle loading, tyres, wind, traffic, and accessories. All dimensions, capacities, and performance figures are approximate. Some features/options may be optional or only available on certain models/trim levels. Images and illustrations are for illustrative purposes only and may not reflect the actual vehicle.

Your use of, or reliance on, any information or contents herein is entirely at your own risk. Toyota Motor Corporation of Japan and Toyota South Africa Motors (Pty) Ltd (including its owners, agents, consultants, employees, and any affiliated person(s)) are not responsible for any loss or damages related to your use of, reliance on, or understanding of any information or contents on this or any other Toyota platform. This includes, without limitation, any direct, indirect, special, incidental, consequential, or punitive damages in terms of any contract, delict (breach of a duty of care) or law.

Furthermore, Toyota Motor Corporation of Japan and Toyota South Africa Motors (Pty) Ltd do not guarantee the uninterrupted or error-free operation of any platform or the availability of content, and are not liable for any interruptions, errors, or damages caused by any technical issues or limitations of these platforms, including but not limited to, server downtime, software malfunctions, or internet connectivity issues.

